



ITALIAN BUFFET

INNOVAZIONE, FLESSIBILITÀ E DESIGN PER BUFFET E BANQUETING CONTEMPORANEI
INNOVATION, FLEXIBILITY AND DESIGN FOR CONTEMPORARY BUFFETS AND BANQUETS

sambonet®



ITALIAN BUFFET BY **SAMBONET**

UN SISTEMA MODULARE DI GRAN CLASSE PER IL BUFFET E IL BANQUETING CONTEMPORANEO. DESIGN, QUALITÀ E INNOVAZIONE SONO OGGI AL SERVIZIO DELLA PERSONALIZZAZIONE E DELLE FLESSIBILITÀ D'UTILIZZO.



A PREMIUM CUSTOMIZABLE SYSTEM FOR CONTEMPORARY BUFFETS AND BANQUETS.

DESIGN, QUALITY AND INNOVATION ALLOW CUSTOMIZATION AND FLEXIBILITY.





HANDY & VERSATILE SYSTEM

Un nuovo sistema modulare per creare un buffet su misura per le proprie esigenze, il punto di forza di Italian Buffet è la personalizzazione. Grazie a una serie di colonne appositamente modellate, la composizione può articolarsi su più livelli attraverso un pratico sistema di piani in legno wengè o in vetro temperato, estremamente raffinati nei materiali e nel gusto, e al tempo stesso solidi e sicuri.

Questo concept assicura estetica, fruibilità e versatilità nella presentazione di cibi, appetizer e bevande oltre a infinite composizioni per via dei differenti componenti di cui è corredato. Da eleganti supporti per chafing dish a funzionali vetrine refrigerate, da alzate di differenti dimensioni e altezze a dispenser per bevande coordinati, Italian Buffet è tutto da scoprire per rinnovare e creare un personalissimo buffet.

Customization is Italian Buffet's strength. This modular system allows to create your own tailor-made buffet. Through a series of specially shaped columns and a practical system of wengè wood and tempered glass shelves manufactured with premium materials and great taste, many different configurations are available.

The customized concept assures an aesthetic, usable and versatile presentation of food, appetizers and drinks, as well as countless configurations. From elegant stands for chafing dishes to refrigerated showcases, from adjustable shelves to coordinated beverage dispensers, Italian Buffet is ideal to discover and reinterpret a very personal buffet.





PERFETTO PER PICCOLE SUPERFICI PER VIA DEL SUO SVILUPPO VERTICALE, ITALIAN BUFFET PUÒ TROVARE MASSIMA ESPRESSIONE IN SCENOGRAFICHE ESPOSIZIONI IN LINEA.

PERFECT FOR SMALL AREAS THANKS TO ITS VERTICAL DESIGN, ITALIAN BUFFET IS IDEAL FOR A DAZZLING VERTICAL DISPLAY.





sambonet







ITALIAN

INNOVATION DESIGN BUFFET



CARATTERISTICHE GENERALI

GENERAL FEATURES

Struttura portante delle vetrine, basi e pianetti di servizio in legno MDF (Medium density fiberboard).
Colonne multi-livello in legno MDF e Plexiglas.
Ripiani in legno MDF e vetro temperato spessore 6 mm.
Parti tubolari in acciaio inox 18/10.



Showcases' main frame, bases and service boards are made of MDF wood (Medium density fiberboard).
Column multi-level risers made of MDF wood and Plexiglas.
Surfaces made of MDF wood and tempered glass, thickness 6 mm.
Tubular metal structure in 18/10 stainless steel.

58383-07**Juice/milk dispenser**

Distributore succhi/latte
 Saft-/Milkdispenser
 Distributeur à jus/lait
 Dispensador de zumo/leche

7 L - 1,73 gal.

**58485-12**59,5x39 cm - h. 30 cm
23 $\frac{3}{8}$ "x15 $\frac{3}{8}$ " - h. 11 $\frac{3}{4}$ "**Cool showcase with tray and roll-top cover GN 1/1**

Vetrina refrigerata con vassoio e roll-top
 Buffet-Vitrine mit Tablett u. Roll-Top
 Vitrine réfrigérée avec plateau et roll-top
 Vitrina refrigerada con bandeja y roll-Top

**58485-02**59,5x39 cm - h. 10 cm
23 $\frac{3}{8}$ "x15 $\frac{3}{8}$ " - h. 3 $\frac{3}{8}$ "**Cool showcase with perforated tray GN 1/1**

Vetrina refrigerata con vassoio forato
 Buffet-Vitrine mit Tablett, gelocht
 Vitrine réfrigérée avec plateau perforé
 Vitrina refrigerada con bandeja perforada

**58485-06**59,5x39 cm - h. 10 cm
23 $\frac{3}{8}$ "x15 $\frac{3}{8}$ " - h. 3 $\frac{3}{8}$ "**Cool showcase with 6 bowls and covers**

Vetrina refrigerata con 6 ciotole con coperchio
 Buffet-Vitrine mit 6 Schalen u. Deckel
 Vitrine réfrigérée avec 6 bols et couvercles
 Vitrina refrigerada con 6 bols y tapas

**58485-00**59,5x39 cm - h. 10 cm
23 $\frac{3}{8}$ "x15 $\frac{3}{8}$ " - h. 3 $\frac{3}{8}$ "**Cool showcase GN 1/1**

Vetrina refrigerata
 Buffet-Vitrine, Kuhlbar
 Vitrine réfrigérée
 Vitrina refrigerada

**58485-AB**59,5x39 cm - h. 20 cm
23 $\frac{3}{8}$ "x15 $\frac{3}{8}$ " - h. 7 $\frac{7}{8}$ "**Roll-top cover, GN 1/1, Plexiglas**

Coperchio roll-top
 Rolltop Deckel
 Couvercle roll-top
 Tapa roll-top

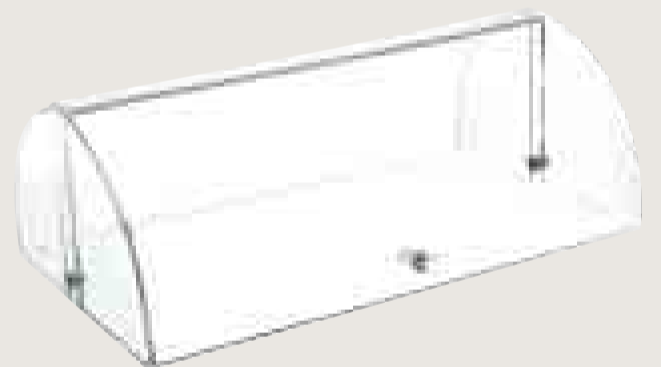
**14102-02**53x32,5 cm - h. 2 cm
20 $\frac{7}{8}$ "x12 $\frac{3}{4}$ " - h. $\frac{3}{4}$ "**Tray, stainless steel, GN 1/1**

Vassoio, inox
 Tablett, Edelstahl Rostfrei
 Plateau, inox
 Bandeja, acero inox

**14202-02****Tray GN 1/1, perforated, stainless steel**

Vassoio forato, inox
 Tablett, gelocht, Edelstahl Rostfrei,
 Plateau perforé, inox
 Bandeja perforada, acero inox



All showcases are equipped with a black polycarbonate GN 1/1 pan # 14802B06 and eutectic pad # 42450-AD.
 Tutte le vetrine sono dotate di bacinella GN 1/1 in policarbonato nero art. 14802B06 e piastra refrigerante art. 42450-AD.

41589-22

Glasses with lid, 12 pieces

Set 12 vasetti con coperchio
 Gläser mit Deckel, 12er Set
 Set 12 verrines avec couvercle
 Juego 12 tarros de vidrio con tapa

ø 7 cm - h. 8 cm. - 220 ml.
 ø 2¾" - h. 3¼" - 0,23 Qts



58489-06

53x32 cm / 20¾"x12½"
 for bowls / per ciotole: ø 14 cm / 5½"

Insert for 6 bowls

Inserto vetrina per 6 ciotole
 Modul für 6 Schüssel
 Module pour 6 bols
 Módulo para 6 bols



58485-AA

53x32 cm / 20¾"x12½"

Cutting board

Tagliere
 Tranchierbrett
 Planche à découper
 Plancha para cortar



ASSEMBLY SOLUTIONS

ESEMPI DI COMPOSIZIONE



COMPOSED BY / COMPOSTA DA :

58485-00 Cool showcase / Base vetrina
58485-AA Cutting board / Tagliere

58485-12 Cool showcase with tray and roll-top
 Vetrina refrigerata con vassoio e roll-top

58489-00 2 Cereal/juice pitcher bar /
 Espositore per 2 brocche acqua/cereali

58401-EP Pitcher / Brocca 2X

58401-EQ Lid for juice pitcher / Coperchio brocca succhi

58401-ER Lid for cereal pitcher / Coperchio brocca cereali



42450-AD 41x21 cm - h. 2,5 cm
16 $\frac{1}{8}$ "x8 $\frac{1}{4}$ " - h. 1"

Eutectic pad

Piastra refrigerante
Kühlakku
Cartouche eutectique
Placa refrigerante

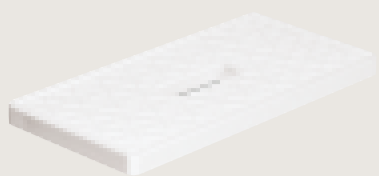

41400-AA ø 23 cm / 9" - H. 10,5 cm / 4 $\frac{1}{8}$ " - 2,5 L / 2,64 Qts
41405-AA ø 14 cm / 5 $\frac{1}{2}$ " - H. 6,5 cm / 2 $\frac{1}{2}$ " - 0,5 L / 0,52 Qts

Round bowl, glass

Ciotola tonda, vetro
Glasschüssel, rund
Bol ronde, verre
Bol redondo, vidrio



44837-25 ø 23 cm / 9" - H. 10,5 cm / 4 $\frac{1}{8}$ " - 2,5 L / 2,64 Qts
44837-05 ø 14 cm / 5 $\frac{1}{2}$ " - H. 6,5 cm / 2 $\frac{1}{2}$ " - 0,5 L / 0,52 Qts
44837B25 ø 23 cm / 9" - H. 10,5 cm / 4 $\frac{1}{8}$ " - 2,5 L / 2,64 Qts black/nero
44837B05 ø 14 cm / 5 $\frac{1}{2}$ " - H. 6,5 cm / 2 $\frac{1}{2}$ " - 0,5 L / 0,52 Qts black/nero

Round bowl, melamine

Ciotola tonda, melamina
Schüssel, rund, Melamin
Bol ronde, melamine
Bol redondo, melamina



42452-23 ø 23 cm / 9"
42452-14 ø 14,5 cm / 5 $\frac{3}{4}$ "

Airtight cover for round bowl, PC

Coperchio ermetico per ciotola tonda
Frischhaltedeckel für Schüssel, rund
Couvercle hermétique pour bol ronde
Tapa hermética para bol redondo



42453-23 ø 23 cm / 9"

Cover, PC

Coperchio
Deckel
Couvercle
Tapa



44995-14

Juice pitcher, glass

Caraffa vetro
Glas-Saftkanne
Carafe à jus de fruits, verre
Jarra zumo, vidrio

ø 16 cm - h. 27 cm. - 1,4 lt.
ø 6 $\frac{1}{4}$ " - h. 10 $\frac{5}{8}$ " - 1,43 Qts



Spout opens and closes automatically. Chromed foot with cooler, keeps drinks chilled up to 4 hours.
Tappo apri/chiodi automatico. Base cromata con eutectico. Mantiene le bevande refrigerate fino a 4 ore.

44995-10

Juice pitcher, glass

Caraffa vetro
Glas-Saftkanne
Carafe à jus de fruits, verre
Jarra zumo, vidrio

ø 9,5 cm - h. 29 cm. - 1 lt.
ø 3 $\frac{3}{4}$ " - h. 11 $\frac{5}{8}$ " - 1,05 Qts



Spout opens and closes automatically.
Tappo apri/chiodi automatico.

58401-EP

Pitcher

Brocca
Kanne
Carafe
Jarra

2 L
2,11 Qts



58401-EQ

Lid for juice pitcher

Coperchio brocca succhi
Saftkannendeckel
Couvercle carafe à jus
Tapa para jarra zumo

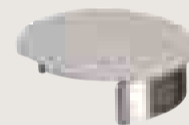

58401-ER

Lid for cereal pitcher

Coperchio brocca cereali
Müslkannendeckel
Couvercle carafe à céréales
Tapa para jarra cereales



58489-00 39x22 cm - h. 10 cm
15 $\frac{1}{8}$ "x8 $\frac{1}{8}$ " - h. 3 $\frac{7}{8}$ "

2 Cereal/juice pitcher-bar

Espositore per 2 brocche acqua/cereali
Saft-/Cerealienkannen-Bar
Présentoir 2 carafes à céréales/jus
Expositor 2 jarras zumo/cereales



58489-VA

Cooling set 2 pcs

Set 2 eutectici
Kühlakku, 2er Set
Set 2 cartouches eutectiques
Juego 2 acumuladores de frío



With 2 silicone non-slip pads / Con 2 tappetini antiscivolo in silicone

ASSEMBLY SOLUTIONS ESEMPI DI COMPOSIZIONE



COMPOSED BY / COMPOSTA DA :

58485-00 Cool showcase / Base vetrina
58489-06 Insert for 6 bowls / inserto vetrina per 6 ciotole
44995-14 Juice pitcher, glass / Caraffa vetro 3X
44837-05 Round bowl / Ciotola tonda 3X
42452-14 Airtight cover, PC / Coperchio ermetico 3x

58489-11 27x33,5 cm / 10 $\frac{5}{8}$ "x13 $\frac{1}{4}$ "

Plain shelf

Pianetto liscio
Regal Glatt
Etagère
Estante liso



58489-10 27x33,5 cm / 10 $\frac{5}{8}$ "x13 $\frac{1}{4}$ "

Bowl holder

Pianetto portaciotole
Schalenhalter
Etagère à bol
Soporte para bol



42462-11 GN 1/1 - h. 6,5 cm / 2 $\frac{1}{2}$ "

42462-12 GN 1/2 - h. 6,5 cm / 2 $\frac{1}{2}$ "

Bread basket, PP

Cesto pane
Brot-Korb
Corbeille à pain
Cesta pan



42452-53 53x32,5 cm - h. 17 cm
20 $\frac{5}{8}$ "x12 $\frac{3}{4}$ " - h. 6 $\frac{3}{4}$ "

GN roll-top cover, PC

Coperchio GN roll-top
GN-Rolltophaube
Couvercle roll-top, GN
Tapa roll-top, GN



42461-11 53x32,5 cm - h. 10 cm
20 $\frac{5}{8}$ "x12 $\frac{3}{4}$ " - h. 3 $\frac{7}{8}$ "

Bread basket, PP

Cesto pane
Brot-Korb
Corbeille à pain
Cesta pan

With frame to fix the cover / con telaio per fissare il coperchio
To be used on table stands / per i supporti # 58489-02 - 58489-03

41419-12 GN 1/2 - 33x28 h. 17 cm / 13"x11" - h. 6 $\frac{3}{4}$ " - for / per # 42462-12

41418-11 GN 1/1 - 54x33 h. 20 cm / 21 $\frac{1}{4}$ "x13" - h. 7 $\frac{7}{8}$ " - for / per # 42462-11

GN cover, SAN

Coperchio GN
GN-Kuppelhaube
Couvercle GN
Campana GN



Front side cut
Con apertura frontale

58489-02 GN 1/1 - GN 1/2

Table stand 2 tiers

Supporto 2 livelli
Tischständer, 2-Stufig
Support de table 2 étages
Soporte de mesa 2 pisos



base: 40x30 cm / 15 $\frac{3}{4}$ "x11 $\frac{1}{8}$ "
overall sizes / ingombro: 48x54 cm - h. 35,5 cm / 18 $\frac{7}{8}$ "x21 $\frac{1}{4}$ " - h. 14"

ASSEMBLY SOLUTIONS ESEMPI DI COMPOSIZIONE

COMPOSED BY / COMPOSTA DA :

58489-02 Table stand 2 tiers

Supporto 2 livelli

42461-11 Basket / Cesto

58489-10 Holder / Pianetto

44837-25 Bowl / Ciotola



58489-03 GN 1/2 - 2X GN 1/1

Table stand 3 tiers

Supporto 3 livelli
Tischständer, 3-Stufig
Support de table 3 étages
Soporte de mesa 3 pisos

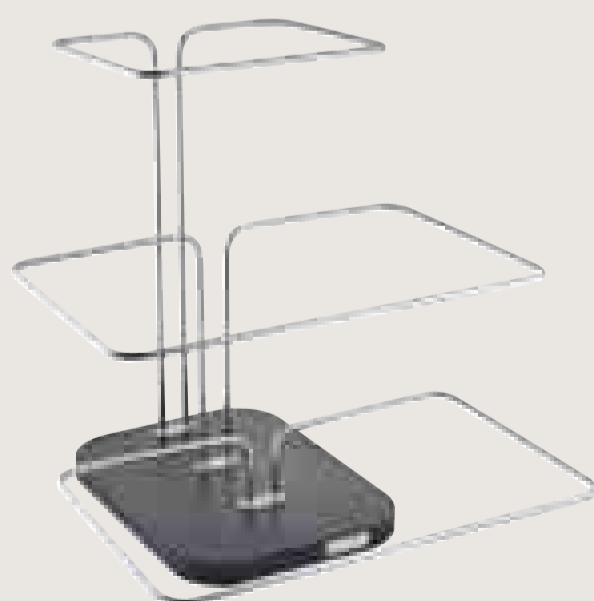

base: 40x30 cm / 15 $\frac{3}{4}$ "x11 $\frac{1}{8}$ "
overall sizes / ingombro: 60x54 cm - h. 58 cm / 23 $\frac{5}{8}$ "x21 $\frac{1}{4}$ " - h. 22 $\frac{3}{4}$ "

58489-13 3X GN 1/2

Table stand 3 tiers

Supporto 3 livelli
Tischständer, 3-Stufig
Support de table 3 étages
Soporte de mesa 3 pisos



base: 40x30 cm / 15 $\frac{3}{4}$ "x11 $\frac{1}{8}$ "
overall sizes / ingombro: 54x33 cm - h. 58 cm / 21 $\frac{1}{4}$ "x13" - h. 22 $\frac{3}{4}$ "



58482-01 40x30 cm - h. 63 cm / 15¾"x11⅞" - h. 24¾"

Multi-level riser, wood
Colonna verticale, legno
Multi-Level Stand, Holz
Support à niveaux multiples, bois
Soporte niveles múltiples, madera

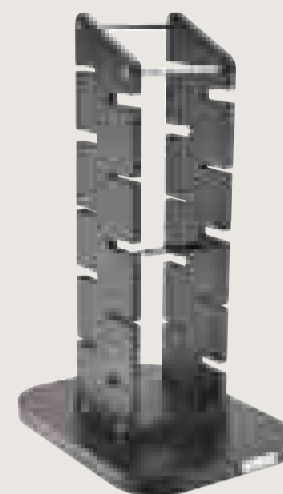

58482-11 40x30 cm - h. 63 cm / 15¾"x11⅞" - h. 24¾"

Multi-level riser, PMMA
Colonna verticale
Multi-Level Stand
Support à niveaux multiples
Soporte niveles múltiples

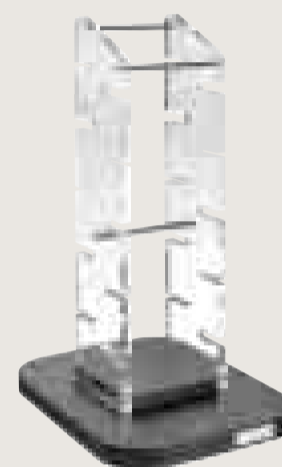

58482-DA 35x35 cm - h. 0,6 cm / 13¾"x13¾" - h. ¼"
58482-DB 35x85 cm - h. 0,6 cm / 13¾"x33½" - h. ¼"

Black tempered glass
Ripiano vetro temperato, fumè
Rauchglasregal
Étagère verre fumé trempé
Vidrio negro templado



58482-BB 35x85 cm - h. 1,5 cm / 13¾"x33½" - h. ⅝"

Wooden shelf
Piano legno
Holzregal
Étagère en bois
Estante de madera

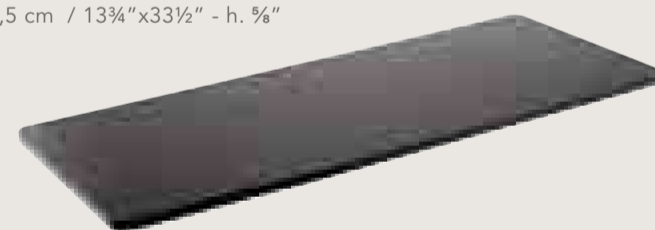

ASSEMBLY SOLUTIONS ESEMPI DI COMPOSIZIONE

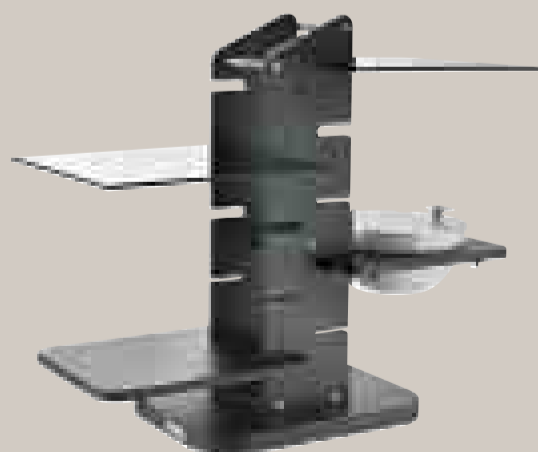

COMPOSED BY / COMPOSTA DA :

58482-01 Multi-level riser, wood / Colonna verticale, legno
58489-11 Plain insert / Pianetto liscio
58489-10 Bowl holder / Pianetto portaciotole
44837-25 Round bowl, melamine / Ciotola tonda, melamina
42452-23 Airtight cover / Coperchio ermetico
58482-DA Black tempered glass / Ripiano vetro temperato, fumè 2X



COMPOSED BY / COMPOSTA DA :

58482-01 Multi-level riser, wood / Colonna verticale, legno 2X
58489-11 Plain insert / Pianetto liscio 2X
58489-10 Bowl holder / Pianetto portaciotole 2X
58482-BB Wooden shelf / Piano legno 3X
44837-25 Round bowl, melamine / Ciotola tonda, melamina 2X
42452-23 Airtight cover, PC / Coperchio ermetico

58186E30 ø 30 cm - 11¾" EU Standard
58186E36 ø 36 cm - 14⅞" EU Standard
58186E40 ø 40 cm - 15¾" EU Standard

58186U36 ø 36 cm - 14⅞" US Standard
58186U40 ø 40 cm - 15¾" US Standard

Chafing dish round
 Scaldavivande tondo
 Chafing Dish, Rund
 Chafing dish rond
 Chafing dish redondo



58482-03

Multi-level riser, wood
 Colonna verticale, legno
 Multi-Level Stand, Holz
 Support à niveaux multiples, bois
 Soporte niveles múltiples, madera



base: 40x30 cm / 15¾"x11⅞"
 overall sizes / ingombro: 60x52 cm - h. 56 cm / 23⅜"x20½" - h. 22"

58482-BA 33,5x52 cm / 13¼"x20½"

Bowl holder, 2 holes
 Pianetto portaciotole, 2 posti
 Schalenhalter 2 Plätze
 Etagère à 2 bols
 Soporte para 2 bols



ASSEMBLY SOLUTIONS ESEMPI DI COMPOSIZIONE



COMPOSED BY / COMPOSTA DA :

58482-03 Multi-level riser / Colonna verticale
58482-BA Bowl holder, 2 holes / Pianetto portaciotole, 2 posti 2X
58489-10 Bowl holder / Pianetto portaciotole
44837-25 Round bowl / Ciotola tonda 5X



58484-10 59,5x33,5 cm - h. 15 cm
23 $\frac{3}{8}$ "x13 $\frac{1}{8}$ " - h. 5 $\frac{7}{8}$ "

58484-11 62,5x33,5 cm - h. 27 cm
24 $\frac{3}{8}$ "x13 $\frac{1}{8}$ " - h. 10 $\frac{5}{8}$ "

Riser
Alzata
Buffet-Ständer
Support
Soporte



58484-03 59,5x24 cm - h. 15 cm
23 $\frac{3}{8}$ "x9 $\frac{1}{2}$ " - h. 5 $\frac{7}{8}$ "

Bowl riser
Alzata portaciotole
Schüssel-Buffet-Ständer
Support à bols
Soporte para bols



58488-28 ø 28 cm / 11" - H. 12 cm / 4 $\frac{3}{4}$ "

58488-38 ø 38 cm / 15" - H. 12 cm / 4 $\frac{3}{4}$ "

58488-78 ø 28 cm / 11" - H. 17 cm / 6 $\frac{5}{8}$ "

58488-88 ø 38 cm / 15" - H. 17 cm / 6 $\frac{5}{8}$ "

Cake stand
Alzata torta
Kuchenständer
Support à tarte
Pedestal para tartas



41585-51 24x15 cm / 9 $\frac{3}{8}$ "x5 $\frac{7}{8}$ "

41585-52 47x10 cm / 18 $\frac{1}{2}$ "x3 $\frac{3}{8}$ "

41585-53 26,5x20,5 cm / 10 $\frac{3}{8}$ "x8"

41585-54 32x12 cm / 12 $\frac{3}{8}$ "x4 $\frac{3}{4}$ "

Natural slate tray
Vassoio ardesia naturale
Naturschieferplatte
Plateau ardoise naturelle
Bandeja de pizarra natural



ASSEMBLY SOLUTIONS ESEMPI DI COMPOSIZIONE



COMPOSED BY / COMPOSTA DA :

58484-10 Riser / Alzata
58485-00 Cool showcase / Base vetrina
58485-AA Cutting board / Tagliere



COMPOSED BY / COMPOSTA DA :

58484-03 Bowl riser / Alzata portaciotole
42452-14 Airtight cover / Coperchio ermetico 3X
44837-25 Round bowl / Ciotola tonda 3X



COMPOSED BY / COMPOSTA DA :

58484-11 Riser / Alzata
58485-00 Cool showcase / Base vetrina
14102-02 Tray / Vassoio
58485-AB Roll-top cover / Coperchio roll-top

ASSEMBLY SOLUTIONS

ESEMPI DI COMPOSIZIONE



MINI

- | | | | | |
|---------------|---------------|---------------|---------------|---------------|
| ① 58489-00 1x | ② 58485-12 1x | ③ 58489-13 1x | ④ 58488-28 1x | ⑤ 58186E30 1x |
| 58401-EP 2x | | 58489-10 2x | | |
| 58401-EQ 2x | | 44837-25 2x | | |
| | | 42452-23 3x | | |
| | | 42462-12 1x | | |

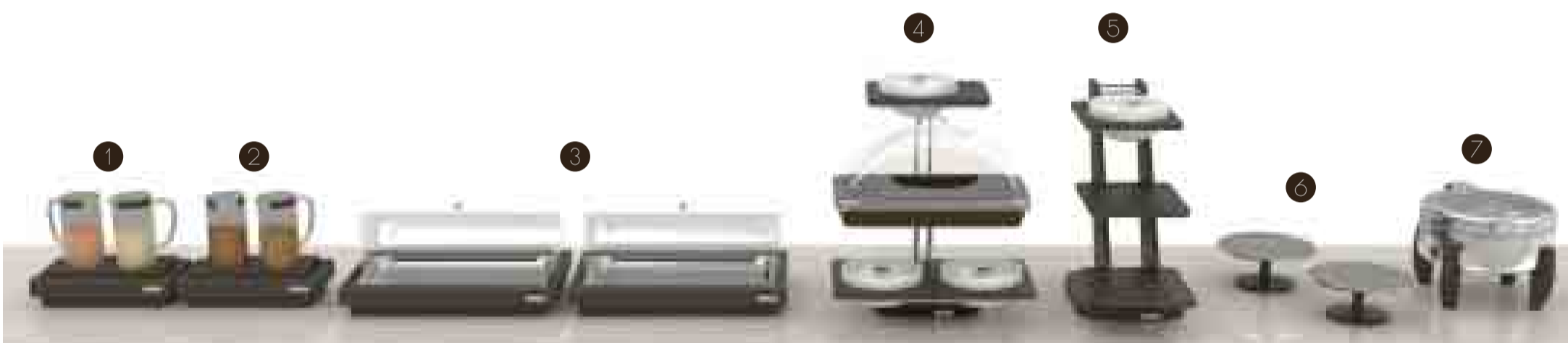

MIDDLE

- | | | | | | | |
|---------------|---------------|---------------|---------------|---------------|---------------|---------------|
| ① 58489-00 1x | ② 58489-00 1x | ③ 58485-12 1x | ④ 58489-03 1x | ⑤ 58489-03 1x | ⑥ 58488-28 1x | ⑦ 58186E36 1x |
| 58401-EP 2x | 58401-EP 2x | | 58489-10 3x | 58489-10 1x | | |
| 58401-EQ 2x | 58401-ER 2x | | 44837-25 3x | 58489-11 2x | | |
| | | | 42452-23 3x | 44837-25 1x | | |
| | | | 42461-11 1x | 42452-23 1x | | |
| | | | 41418-11 1x | | | |

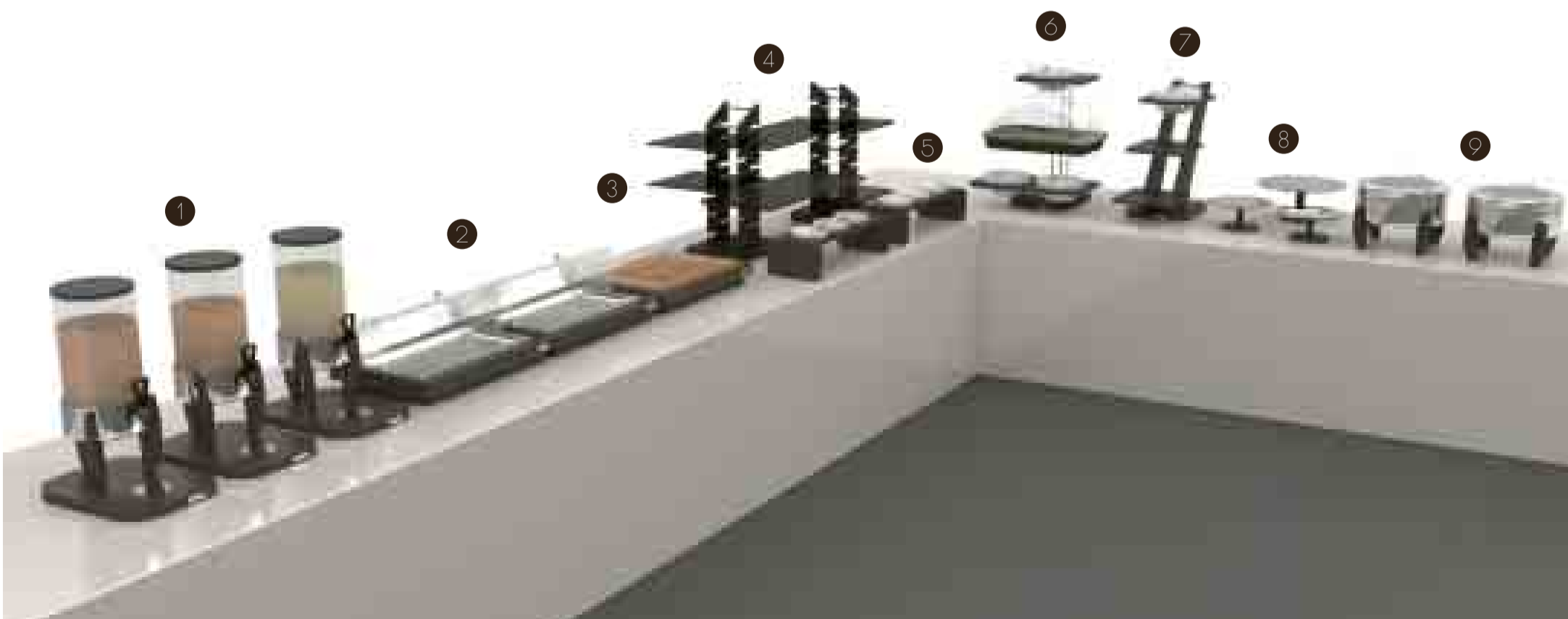

MAGNUM

- | | | | | | | |
|---------------|---------------|---------------|---------------|---------------|---------------|---------------|
| ① 58383-07 3x | ④ 58482-01 2x | ⑤ 58484-03 2x | ⑥ 58489-03 1x | ⑦ 58482-03 1x | ⑧ 58488-28 2x | ⑨ 58186E36 2x |
| | 58482-BB 1x | 42452-14 6x | 58489-10 3x | 58489-10 1x | 58488-88 1x | |
| ② 58485-12 2x | 58482-DB 1x | 41405-AA 6x | 44837-25 3x | 58489-11 2x | | |
| | 58482-DA 2x | | 42452-23 3x | 44837-25 1x | | |
| ③ 58485-00 1x | 58489-11 1x | | 42461-11 1x | 42452-23 1x | | |
| 58485-AA 1x | | | 41418-11 1x | | | |



SAMBONET PADERNO INDUSTRIE S.P.A.

S.R. 11, Km 84 - 28060 Orfengo (No) - Italy

T +39 0321 879 601
 T +39 0321 1916 822
 F +39 0321 879 890
 F +39 0321 1916 890

horeca@sambonet.it

www.hotel.sambonet.it
 www.sambonet.it
 corporate.sambonet.it

ROSENTHAL SAMBONET USA, LTD.

355 Michele Place - Carlstadt, NJ 07072

P +1 201 804 8000
 F +1 201 842 9195

info@rosenthalusa.com
 www.rosenthal-hotel-restaurant.com

ROSENTHAL GMBH HOTEL & RESTAURANT SERVICE

Philip-Rosenthal-Platz 1 - D -95100 Selb - Germany

T +49 09287 72 377
 F +49 09287 72 385

hrs@rosenthal.de
 www.hotel.rosenthal.de

UNI EN ISO 9001:2008



SISTEMA DI GESTIONE QUALITÀ CERTIFICATO

CERTIFICATO N° 10571

UNI EN ISO 14001:2004



SISTEMA DI GESTIONE AMBIENTALE CERTIFICATO

CERTIFICATO N° 8728

BS OHSAS 18001:2007



SISTEMA DI GESTIONE SICUREZZA CERTIFICATO

CERTIFICATO N° 10573

UNI EN ISO 22000:2005



SISTEMA DI GESTIONE PER LA SICUREZZA ALIMENTARE CERTIFICATO

CERTIFICATO N° 18888

UNI CEI EN ISO 50001:2011



SISTEMA DI GESTIONE DELL'ENERGIA CERTIFICATO

CERTIFICATO N° 21636

UNI EN ISO 9001:2008
 UNI EN ISO 14001:2004
 BS OHSAS 18001:2007



SISTEMI DI GESTIONE CERTIFICATI

CERTIFICATO N° 093



LABORATORIO DI ANALISI INTERNO CERTIFICATO



LAB N°1407